

KATALOG IZDELKOV ZA TEKSTILNO INDUSTRIJO



KOVIC, d.o.o.,

družba za proizvodnjo in predelavo kovin in plastičnih mas,
Dob pri Domžalah, Slovenija, EU

www.kovic.si

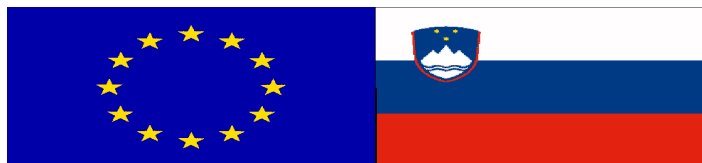



PLASTICNE KONUSNE CEVKE

TIP: 33/145

* ϕ 33 *

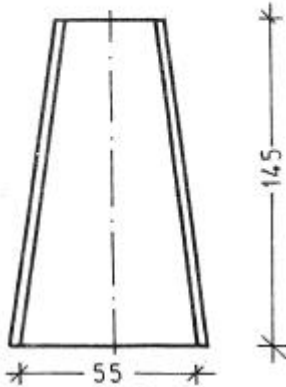

Konus: 4°20''
Višina: 145 mm
? osnovni: 55 mm

Cena: _____ euro

TIP 33/170

* ϕ 33 *

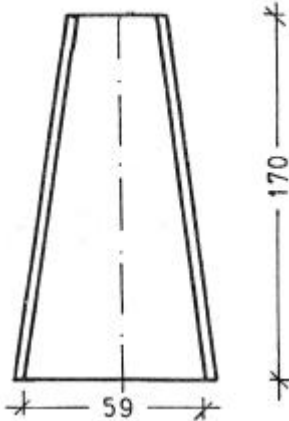

Konus: 4°20''
Višina: 170 mm
? osnovni: 59 mm

Cena: _____ euro

TIP 17/170

* ϕ 17 *

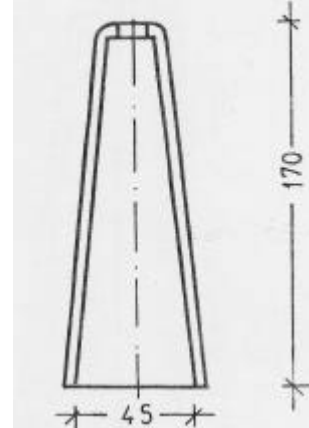

Konus: 3°30''
Višina: 170 mm
? osnovni: 45 mm

Cena: _____ euro

TIP: 35/290

* ϕ 35 *

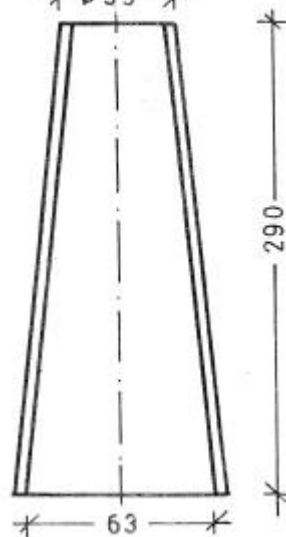

Konus: 3°30''
Višina: 290 mm
? osnovni: 63 mm

Cena: _____ euro

TIP: 24/230

* ϕ 24 *

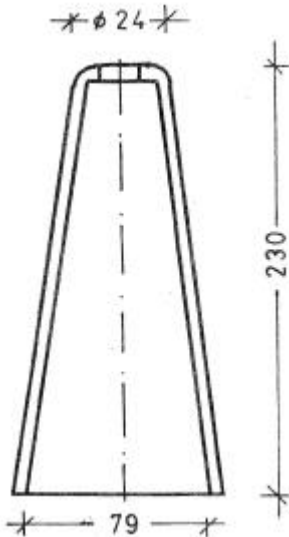

Konus: 3°30''
Višina: 230 mm
? osnovni: 79 mm

Cena: _____ euro

TIP: 27/290

* ϕ 27 *

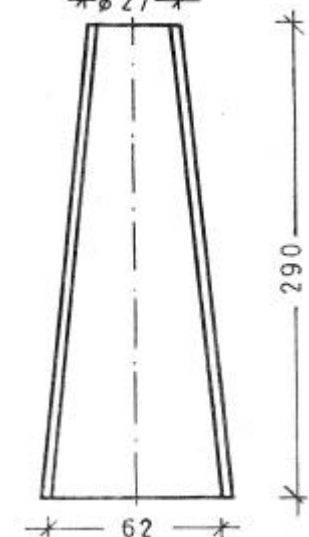

Konus: 4°20''
Višina: 290 mm
? osnovni: 62 mm

Cena: _____ euro

Možnost izbora barv: po želji



PLASTICNE KONUSNE CEVKE

TIP: 28/170

* ϕ 28 *

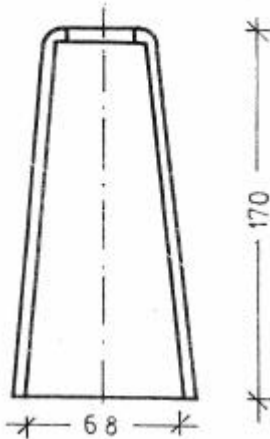

Konus: 5°57''
Višina: 170 mm
? osnovni: 68 mm

Cena: _____ euro

TIP 33/170

* ϕ 33 *

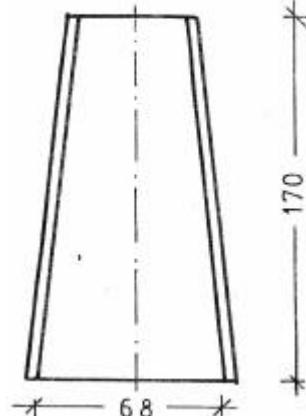

Konus: 5°57''
Višina: 170 mm
? osnovni: 68 mm

Cena: _____ euro

TIP 24/175

* ϕ 24 *

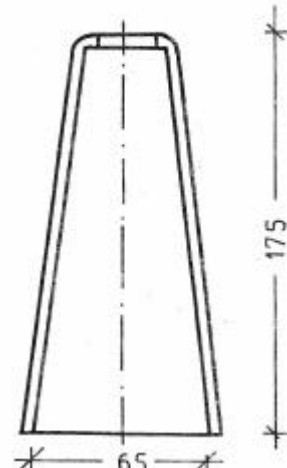

Konus: 5°57''
Višina: 175 mm
? osnovni: 65 mm

Cena: _____ euro

TIP: 30/170

* ϕ 30 *

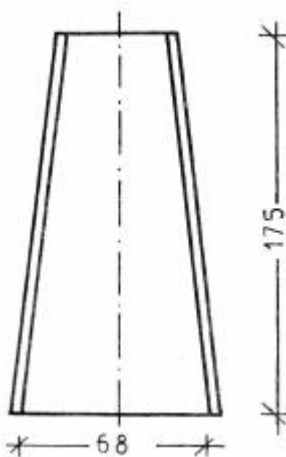

Konus: 5°57''
Višina: 175 mm
? osnovni: 68 mm

Cena: _____ euro

TIP: 30/230

* ϕ 30 *

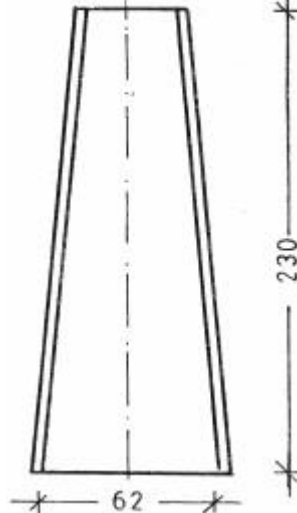

Konus: 4°20''
Višina: 230 mm
? osnovni: 62 mm

Cena: _____ euro

TIP: 10/180

* ϕ 10 *

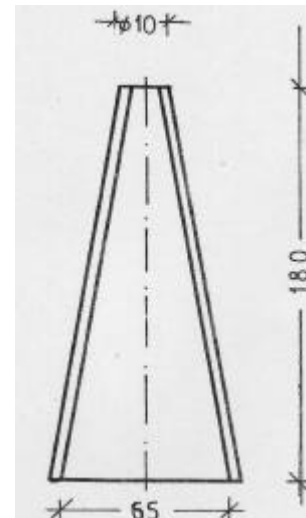

Konus: 9°15''
Višina: 180 mm
? osnovni: 65 mm

Cena: _____ euro

Možnost izbora barv: po želji



PERFORIRANE PLASTICNE KONUSNE CEVKE

Po želji so odporni na agresivnost pare ter na višje temperature, od 110-130 °C.
Oblike perforacije : okrogle, trikotne, romboidne. Možnost izbora barv: po želji.

TIP: 33/145

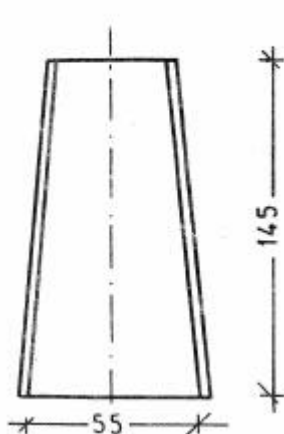
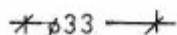

Konus: 4°20''
Višina: 145 mm
? osnovni: 55 mm

Cena: _____ euro

TIP 33/170

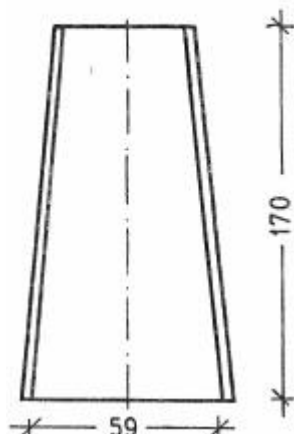
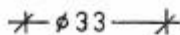

Konus: 4°20''
Višina: 170 mm
? osnovni: 59 mm

Cena: _____ euro

TIP 33/173

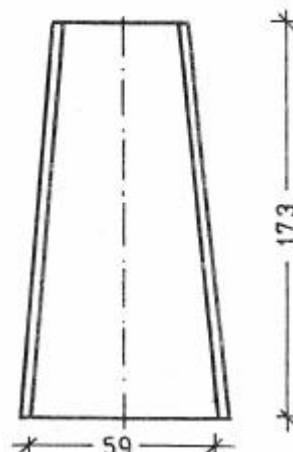
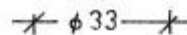

Konus: 4°20''
Višina: 173 mm
? osnovni: 59 mm

Cena: _____ euro

TIP: 33/175

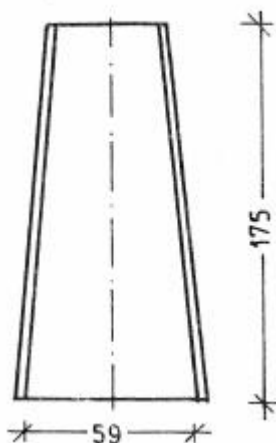
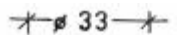

Konus: 4°20''
Višina: 175 mm
? osnovni: 59 mm

Cena: _____ euro

TIP: 33/170

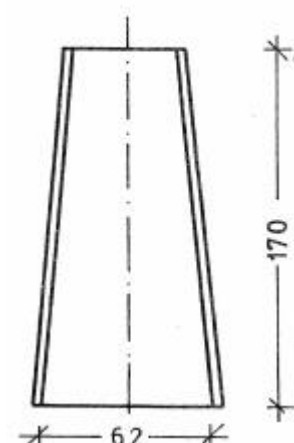
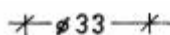

Konus: 5°57''
Višina: 170 mm
? osnovni: 62 mm

Cena: _____ euro

TIP: 45/230

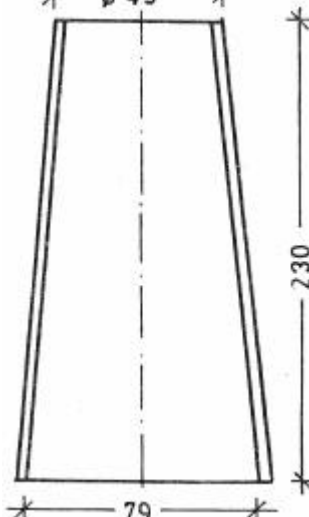

Konus: 4°20''
Višina: 230 mm
? osnovni: 79 mm

Cena: _____ euro



DVOJNI PERFORIRANI PLASTICNI KOLUTI

Po želji so odporni na agresivnost pare ter na temperature od 110-130 °C.
Oblike perforacije : okrogle s krožnimi trakovi 12 mm. Možnost izbora barv : po želji

TIP: 145/III

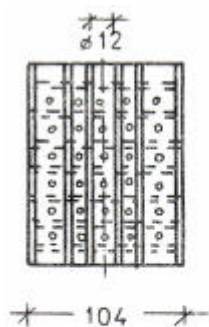

Višina: 145 mm
? zunanji: 104 mm
? nosilca: 12 mm

Cena: _____euro

TIP 145/II

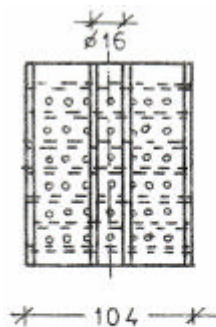

Višina: 145 mm
? zunanji: 104 mm
? nosilca: 16 mm

Cena: _____euro

TIP 145

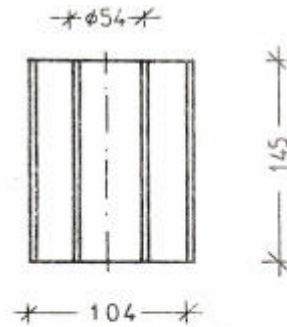

Višina: 145 mm
? zunanji: 104 mm
? nosilca: 54 mm

Cena: _____euro

TIP: 170

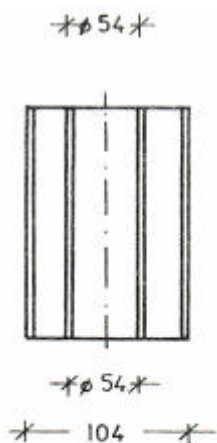

Višina: 170 mm
? zunanji: 104 mm
? nosilca: 54 mm

Cena: _____euro

TIP: 170/K

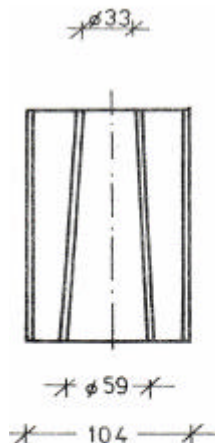

Višina: 170 mm
? zunanji: 104 mm
? nosilca: 59 mm

Cena: _____euro

TIP: 230/K

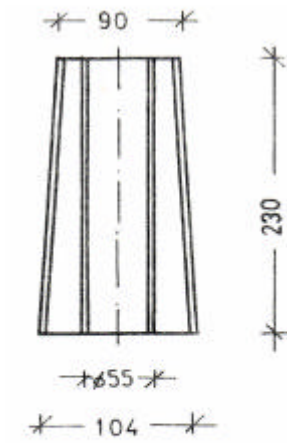

Višina: 230 mm
? zunanji: 104/90 mm
? nosilca: 55 mm

Cena: _____euro



**KOVIC družba za proizvodnjo in predelavo kovin in
plasticnih mas, d.o.o., Dob pri Domžalah**
Kidriceva 13, 1233 Dob pri Domžalah
Tel.:01/7225-340, Fax: 01/7225-345, E-mail: kovic@siol.net

"HAMEL" KOLUTI

Za HAMEL stroje proizvodimo vse vrste kolotov za prvo in drugo navitje.

Proizvajamo tudi zaščitne pokrove ter glave z malim, velikim in notranjim navojem.

Možnost izbora barv: po želji

RAVNE CILINDRICNE CEVKE

Koluti so odporni proti visokim pritiskom ter temperaturam do 130°C.

Možnost izbora barv: po želji

TIP: 100

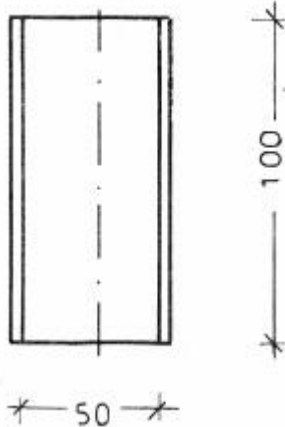

Višina: 100 mm
? zunanji: 56 mm
? notranji: 50 mm

Cena: _____euro

TIP: 114/P

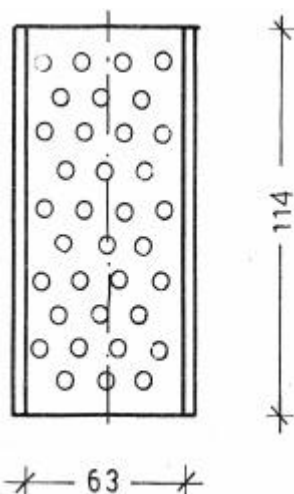

Višina: 114 mm
? zunanji: 72 mm
? notranji: 63 mm

Cena: _____euro

TIP: 150

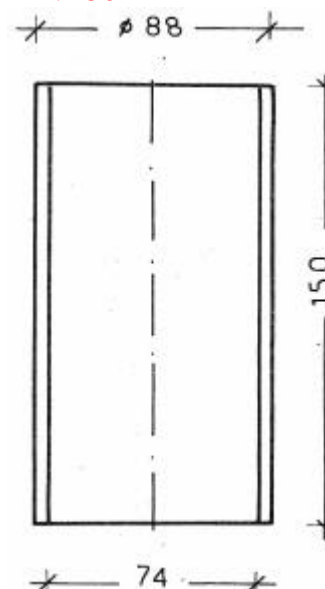

Višina: 150 mm
? zunanji: 88 mm
? notranji: 74 mm

Cena: _____euro



**KOVIC družba za proizvodnjo in predelavo kovin in
plasticnih mas, d.o.o., Dob pri Domžalah**
Kidriceva 13, 1233 Dob pri Domžalah
Tel.:01/7225-340, Fax: 01/7225-345, E-mail: kovic@siol.net

RAVNE CILINDRICNE CEVKE

Koluti so odporni proti visokim pritiskom ter temperaturam do 130°C.

TIP: 170

∅ 60

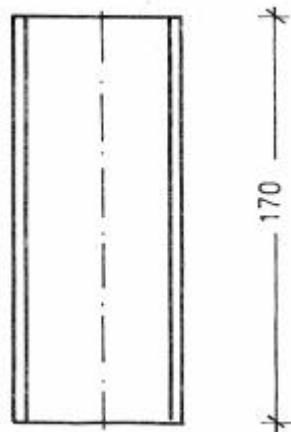

Višina: 170 mm
? zunanji: 60 mm
? notranji: 54 mm

Cena: _____euro

TIP: 170/A

∅ 68

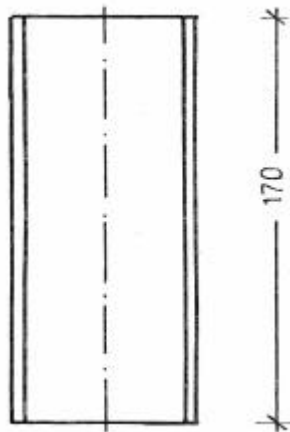

Višina: 170 mm
? zunanji: 68 mm
? notranji: 63 mm

Cena: _____euro

TIP: 180

∅ 76

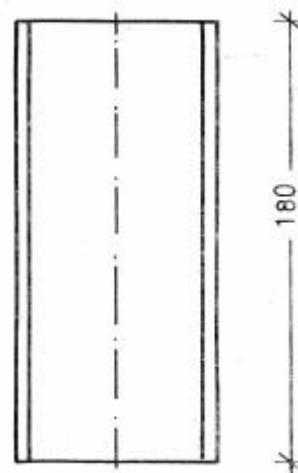

Višina: 180 mm
? zunanji: 76 mm
? notranji: 68 mm

Cena: _____euro

TIP: 230

∅ 61

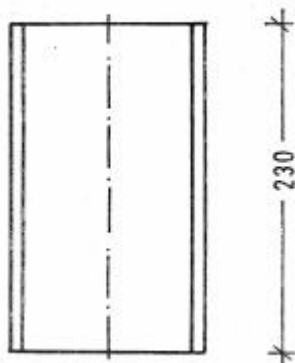

Višina: 230 mm
? zunanji: 61 mm
? notranji: 55 mm

Cena: _____euro

TIP: 290

∅ 90

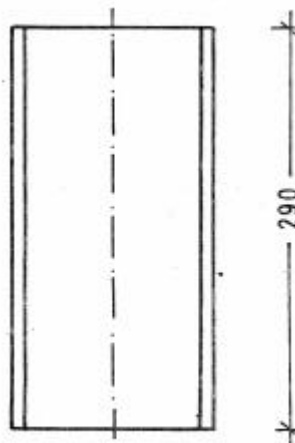

Višina: 290 mm
? zunanji: 90 mm
? notranji: 82 mm

Cena: _____euro

Možnost izbora barv: po želji



**KOVIC družba za proizvodnjo in predelavo kovin in
plasticnih mas, d.o.o., Dob pri Domžalah**
Kidriceva 13, 1233 Dob pri Domžalah
Tel.:01/7225-340, Fax: 01/7225-345, E-mail: kovic@siol.net

FINIŠER KOLUTI ZA ŠLUMBERGER IN SAVIO

TIP: 230

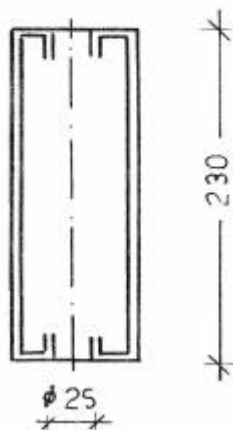
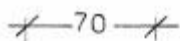

Višina: 230 mm
? zunanji: 70 mm
? notranji: 25 mm

Cena: _____euro

TIP: 240

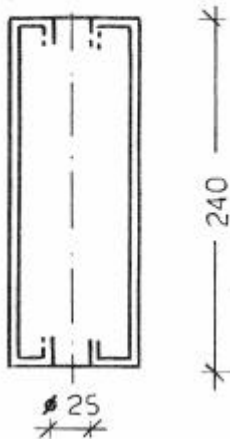
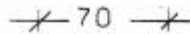

Višina: 240 mm
? zunanji: 70 mm
? notranji: 25 mm

Cena: _____euro

TIP: 290

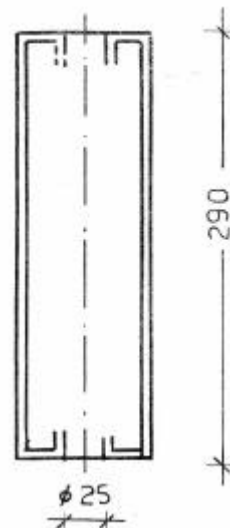

Višina: 290 mm
? zunanji: 70 mm
? notranji: 25 mm

Cena: _____euro

TIP: 245/KS

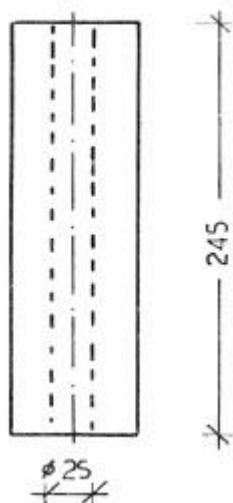

Višina: 245 mm
? zunanji: 60 mm
? notranji: 25 mm

Cena: _____euro

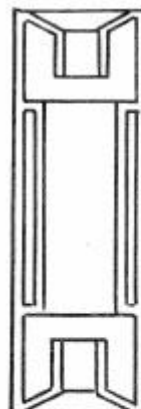

Možnost izbora barv: po želji



SAVIO KOLUTI

TIP: PIKOLO

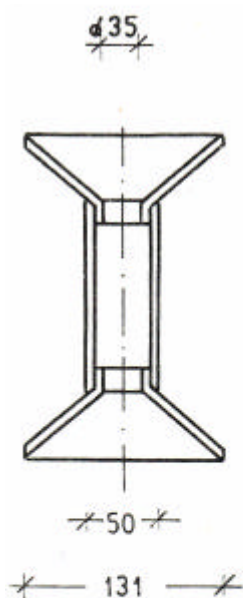

Višina: 208 mm
?/L vrat: 50:35/120 mm
? največji: 131 mm
Širina/bocni kot: 60 mm/45°

Cena: _____euro

TIP: PIKOLO/R

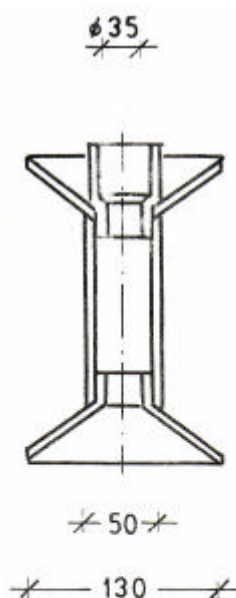

Višina: 201 mm
?/L vrat: 50:34/137 mm
? največji: 130 mm
Širina/bocni kot: 50 mm/35°

Cena: _____euro

TIP: STANDARD

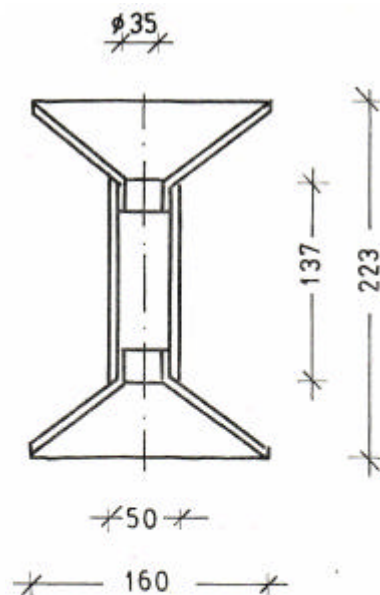

Višina: 223 mm
?/L vrat: 50:35/135 mm
? največji: 160 mm
Širina/bocni kot: 70 mm/35°

Cena: _____euro

Možnost izbora barv : po želji



**KOVIC družba za proizvodnjo in predelavo kovin in
plasticnih mas, d.o.o., Dob pri Domžalah**
Kidriceva 13, 1233 Dob pri Domžalah
Tel.:01/7225-340, Fax: 01/7225-345, E-mail: kovic@siol.net

SAVIO KOLUTI

TIP: STANDARD/R

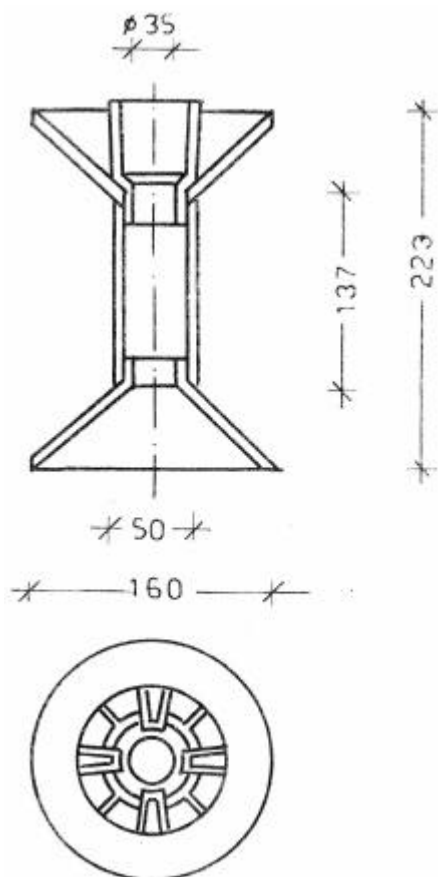

Višina: 223 mm
?/L vrat: 50:35/137 mm
? največji: 160 mm
Širina/bocni kot: 75 mm/35°

Cena: _____euro

TIP: GROSS

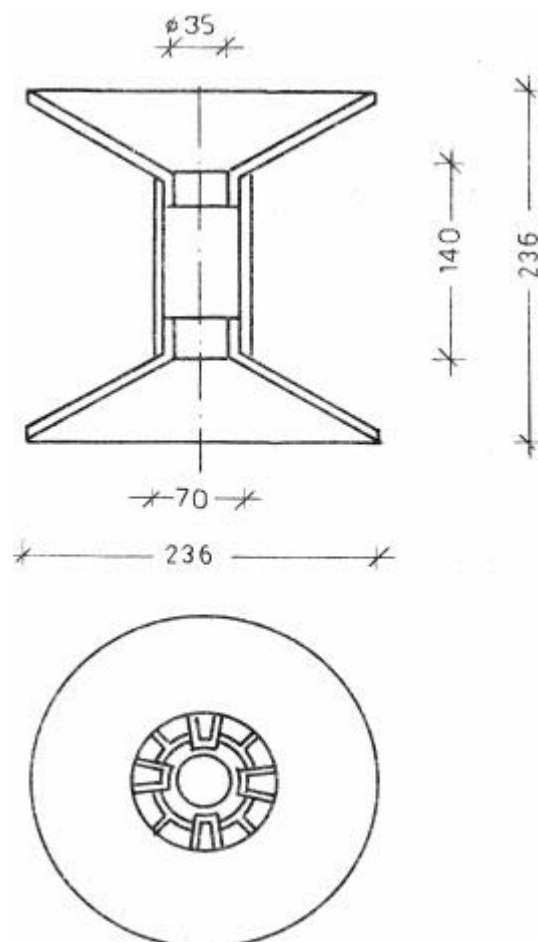

Višina: 236 mm
?/L vrat: 70:35/140 mm
? največji: 236 mm
Širina/bocni kot: 70 mm/35°

Cena: _____euro

Možnost izbora barv: po želji



**KOVIC družba za proizvodnjo in predelavo kovin in
plastčnih mas, d.o.o., Dob pri Domžalah**
Kidriceva 13, 1233 Dob pri Domžalah
Tel.:01/7225-340, Fax: 01/7225-345, E-mail: kovic@siol.net

SEPARATORJI

V proizvodnem programu imamo 18 tipov SEPARATORJEV različnih širin, dolžin ters podlogo kombinacije kovine in plastike.

Po Vašem vzorcu lahko proizvedemo kakršenkoli tip separatorja.

FLAJER KOLUTI

TIP: 290

41

**
ø 20



290

32

418



Višina: 290 mm
? osnovni: 32 mm
? zunanji: 41 mm

Cena: _____euro

TIP:340

40

**
ø 25



340

40

55



Višina: 340 mm
? osnovni: 40 mm
? zunanji: 48 mm

Cena: _____euro

TIP: 400

47

**
ø 25



400

40

55



Višina: 400 mm
? osnovni: 40 mm
? zunanji: 47 mm

Cena: _____euro



**KOVIC družba za proizvodnjo in predelavo kovin in
plasticnih mas, d.o.o., Dob pri Domžalah**
Kidriceva 13, 1233 Dob pri Domžalah
Tel.:01/7225-340, Fax: 01/7225-345, E-mail: kovic@siol.net

FLAJER KOLUTI

TIP: 400/GR

41

*
ø 20

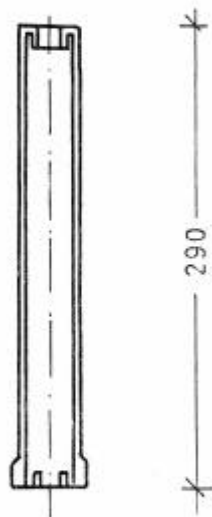

32

418



Višina: 400 mm
? osnovni: 40 mm
? zunanji: 42 mm

Cena: _____ euro

TIP: 400/RK

40

*
ø 25



40

55



Višina: 400 mm
? osnovni: 40 mm
? zunanji: 60 mm

Cena: _____ euro



PREDILNIŠKI VARKOPS IN HAMEL KOLUTI RAZLIČNIH DIMENZIJ

Koluti so različnih premerov ter dolžin od 230-600 mm. Primerni so za klasično uporabo ter uporabo ob višjih pritiskih, ob prisotnosti pare in pri visokih temperaturah od 110-130 °C.

TIP: 230

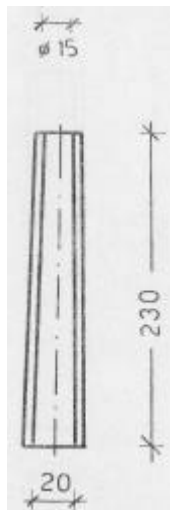

Višina: 230 mm
? notranji: 15/20 mm

Cena: _____euro

TIP 265

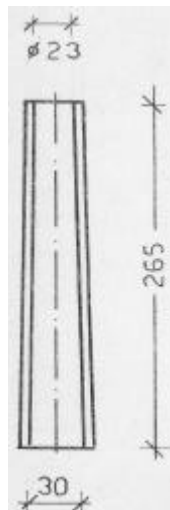

Višina: 265 mm
? notranji: 23/30 mm

Cena: _____euro

TIP 270

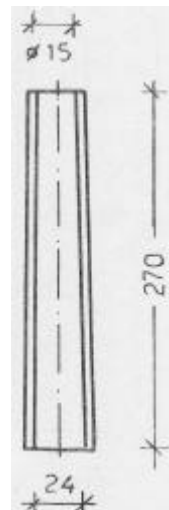

Višina: 270 mm
? notranji: 15/24 mm

Cena: _____euro

TIP: 300

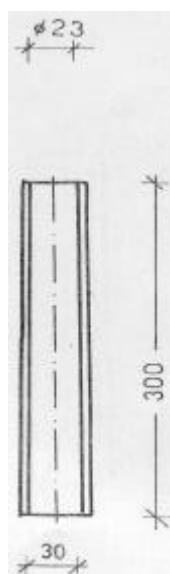

Višina: 300 mm
? notranji: 23/30 mm

Cena: _____euro

TIP: 320

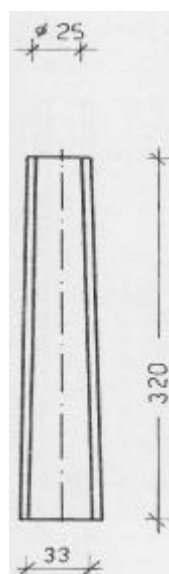

Višina: 320 mm
? notranji: 25/33 mm

Cena: _____euro

TIP: 400

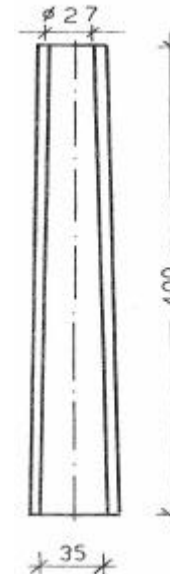

Višina: 400 mm
? notranji: 27/35 mm

Cena: _____euro



KOVIC družba za proizvodnjo in predelavo kovin in plasticnih mas, d.o.o., Dob pri Domžalah
Kidriceva 13, 1233 Dob pri Domžalah
Tel.:01/7225-340, Fax: 01/7225-345, E-mail: kovic@siol.net

PREDILNIŠKI VARKOPS IN HAMEL KOLUTI RAZLIČNIH DIMENZIJ

TIP: 400- I



Višina: 400 mm
? notranji: 30/40 mm

Cena: _____euro

TIP: 420



Višina: 420 mm
? notranji: 32/42 mm

Cena: _____euro

TIP: 450

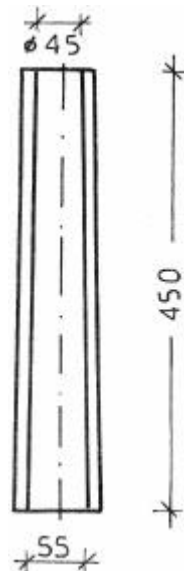

Višina: 450 mm
? notranji: 45/55 mm

Cena: _____euro

TIP: 450 - I



Višina: 450 mm
? notranji: 60/70 mm

Cena: _____euro

TIP: 520



Višina: 520 mm
? notranji: 36/48 mm

Cena: _____euro

TIP: 600

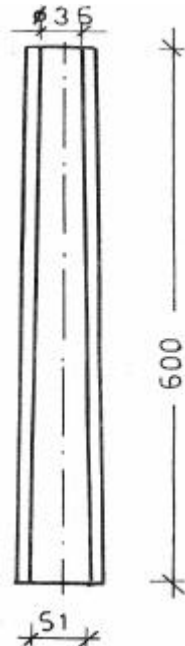

Višina: 600 mm
? notranji: 36/51 mm

Cena: _____euro



**KOVIC družba za proizvodnjo in predelavo kovin in
plasticnih mas, d.o.o., Dob pri Domžalah**
Kidriceva 13, 1233 Dob pri Domžalah
Tel.:01/7225-340, Fax: 01/7225-345, E-mail: kovic@siol.net

PREDILNIŠKI VARKOPS IN HAMEL KOLUTI RAZLIČNIH DIMENZIJ

TIP: 600 - I

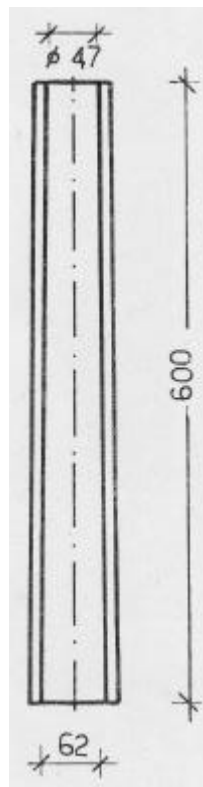

Višina: 600 mm
? notranji: 47/62 mm

Cena: _____ euro

TIP: 615

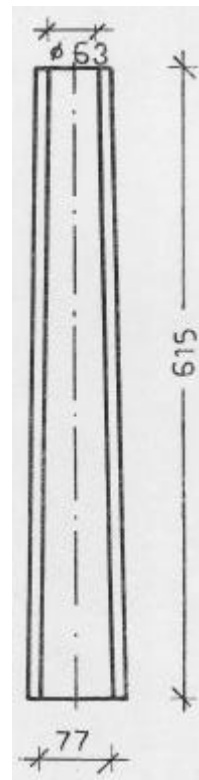

Višina: 615 mm
? notranji: 63/77 mm

Cena: _____ euro

**Koluti so različnih premerov ter dolžin od 230-600 mm. Primerni so za klasično uporabo
in uporabo ob višjih pritiskih, ob prisotnosti pare ter pri visokih temperaturah od
110-130 °C.**

Možnost izbire barv: po želji.



**KOVIC družba za proizvodnjo in predelavo kovin in
plasticnih mas, d.o.o., Dob pri Domžalah**
Kidriceva 13, 1233 Dob pri Domžalah
Tel.:01/7225-340, Fax: 01/7225-345, E-mail: kovic@siol.net

PLASTICNI KOLUTI – ZAROBLJENI

Primerni so za klasično previjanje ter specialno ob višjih pritiskih in pri visokih temperaturah do 130 °C.

TIP: 197

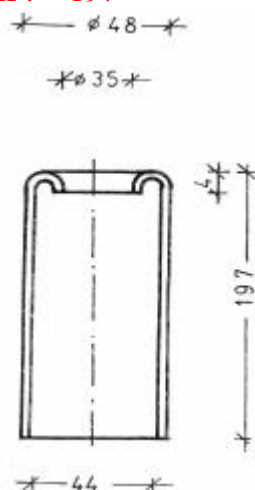

Višina: 197 mm
? zunanji: 48 mm
? notranji: 44 mm

Cena: _____ euro

TIP: 230

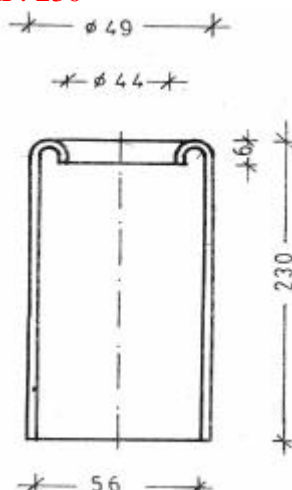

Višina: 230 mm
? zunanji: 59 mm
? notranji: 56 mm

Cena: _____ euro

TIP: 230/P

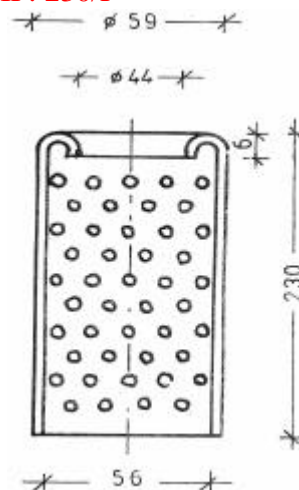

Višina: 230 mm
? zunanji: 59 mm
? notranji: 56 mm

Cena: _____ euro

TIP: 230/A

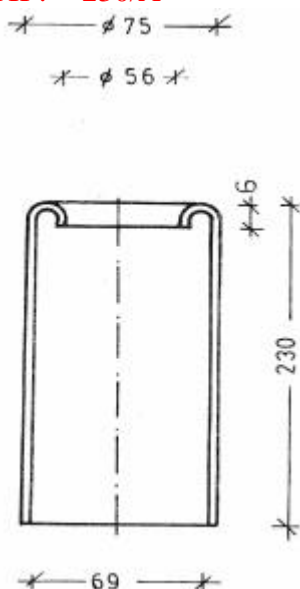

Višina: 230 mm
? zunanji: 75 mm
? notranji: 69 mm

Cena: _____ euro

TIP: 230/B

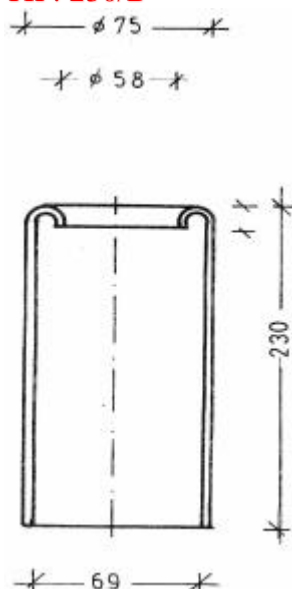

Višina: 230 mm
? zunanji: 75 mm
? notranji: 69 mm

Cena: _____ euro

TIP: 290

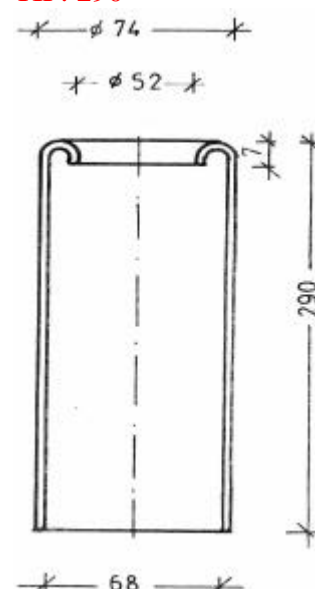

Višina: 290 mm
? zunanji: 74 mm
? notranji: 68 mm

Cena: _____ euro

Možnost izbire barv : po želji



**KOVIC družba za proizvodnjo in predelavo kovin in
plasticnih mas, d.o.o., Dob pri Domžalah**
Kidriceva 13, 1233 Dob pri Domžalah
Tel.:01/7225-340, Fax: 01/7225-345, E-mail: kovic@siol.net

KOLUTI ZA POZAMENTERIJO

TIP: RKD

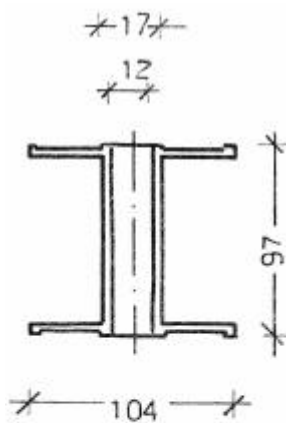

Višina: 97 mm
L nosilna: mm
? koluta: 104 mm
? nosilca: 12 mm

Cena: _____euro

TIP: RKD/1

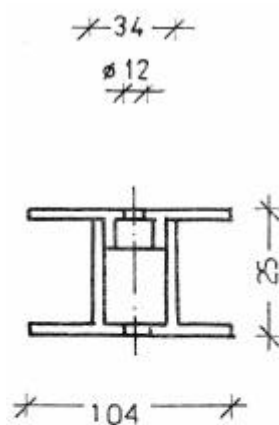

Višina: 17-40 mm
L nosilna: 12-35 mm
? koluta: 104 mm
? nosilca: 12 mm

Cena: _____euro



**KOVIC družba za proizvodnjo in predelavo kovin in
plasticnih mas, d.o.o., Dob pri Domžalah**
Kidriceva 13, 1233 Dob pri Domžalah
Tel.:01/7225-340, Fax: 01/7225-345, E-mail: kovic@siol.net

KOLUTI ZA POZAMENTERIJO

TIP: RKD/S

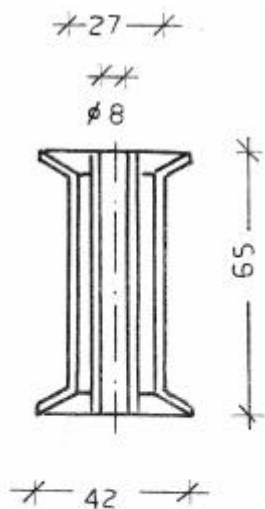

Višina: 65 mm
L nosilna: mm
? koluta: 42 mm
? nosilca: 8 mm

Cena: _____euro

TIP: RKD/C

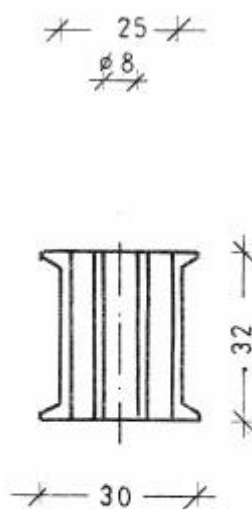

Višina: 32 mm
L nosilna: mm
? koluta: 30 mm
? nosilca: 8 mm

Cena: _____euro